

Rear Portal Axle Units for Axial Wraith

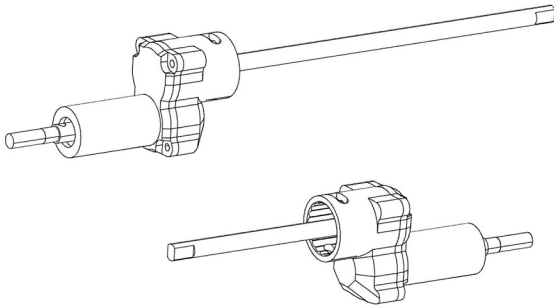

1.

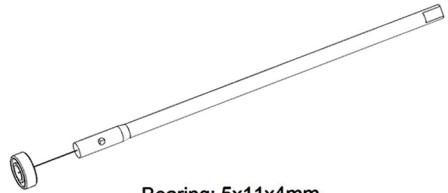

Bearing: 5x11x4mm

2.

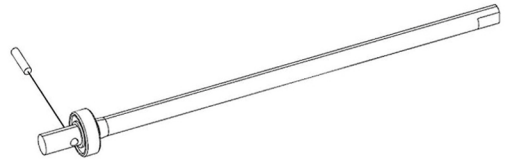

Pin: 2x8mm

3.



Gear: 15T 32P

4.

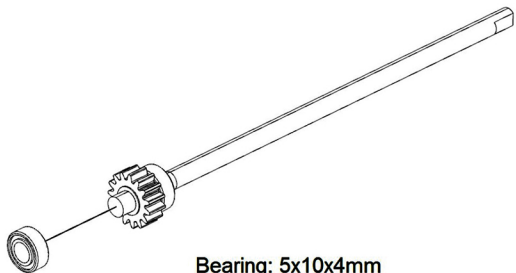

Bearing: 5x10x4mm

5.

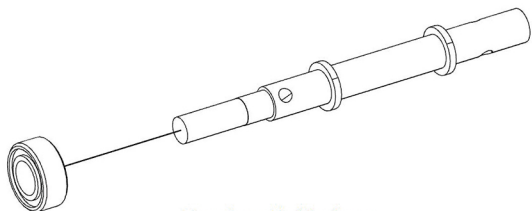

Bearing: 5x10x4mm

6.

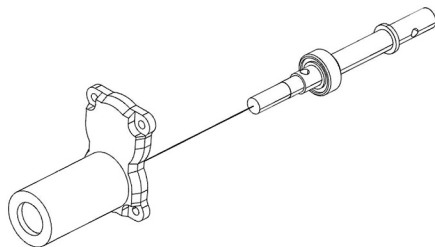

7.

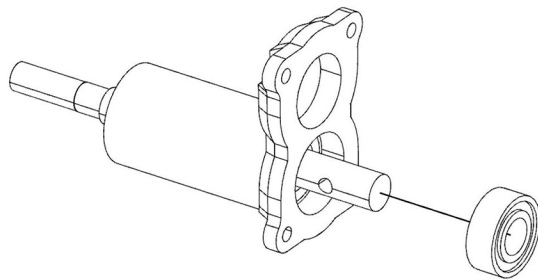

Bearing: 5x11x4mm

8.

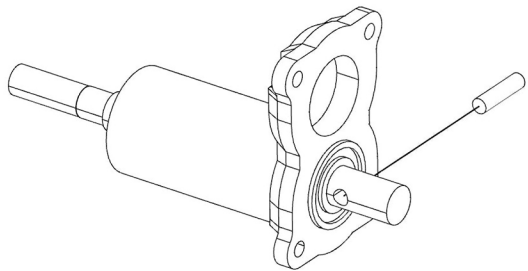

Pin: 2x8mm

9.

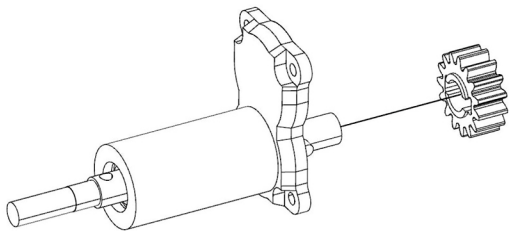

Gear: 15T 32P

10.

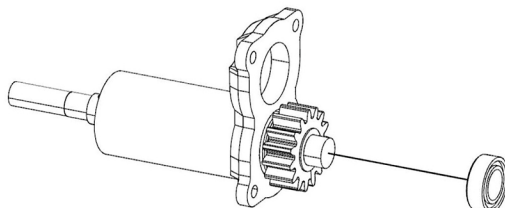

Bearing: 5x9x3mm

11.

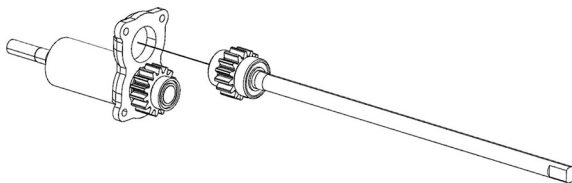

12.

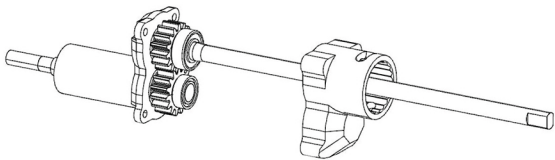

13. Using Medium Grade Threadlock is Suggested
(Not Included)

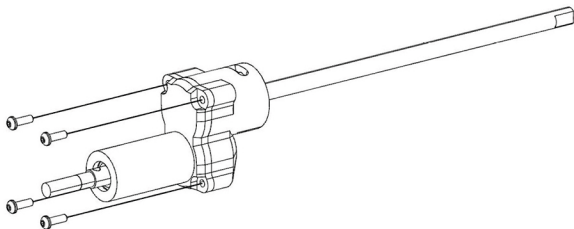

M2x6mm BHCS

Please Complete these Steps for both Rear Portal Units

14. Stock M3x6mm Plastic Thread Screws (Not Included)

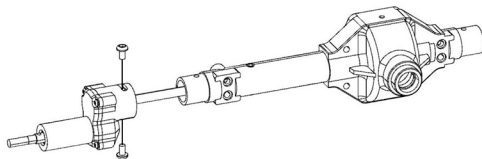

15. Stock M3x6mm Plastic Thread Screws (Not Included)

